

Endkampf

Mahler, Julia
Leipzig Taifun

8

227

16

Opelt, Jessica
Hildburghausen

n. Pkt.

		Endkampf		
Bauer, Caroline				Basar, Dilara
Aken	12	225	32	Landeskader BTV
		12 Pkt.		

Endkampf

Bierstedt, Lucie		Demirkol , Mihriban
Magdeburg Kobras	13 223 8	Landeskader BTV
	n. Pkt.	

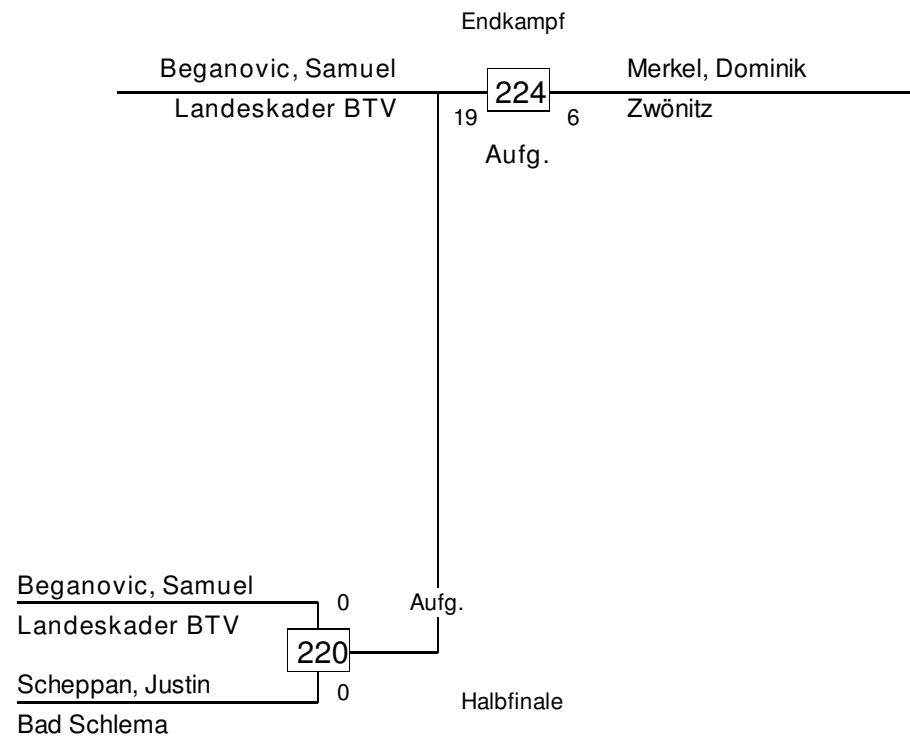

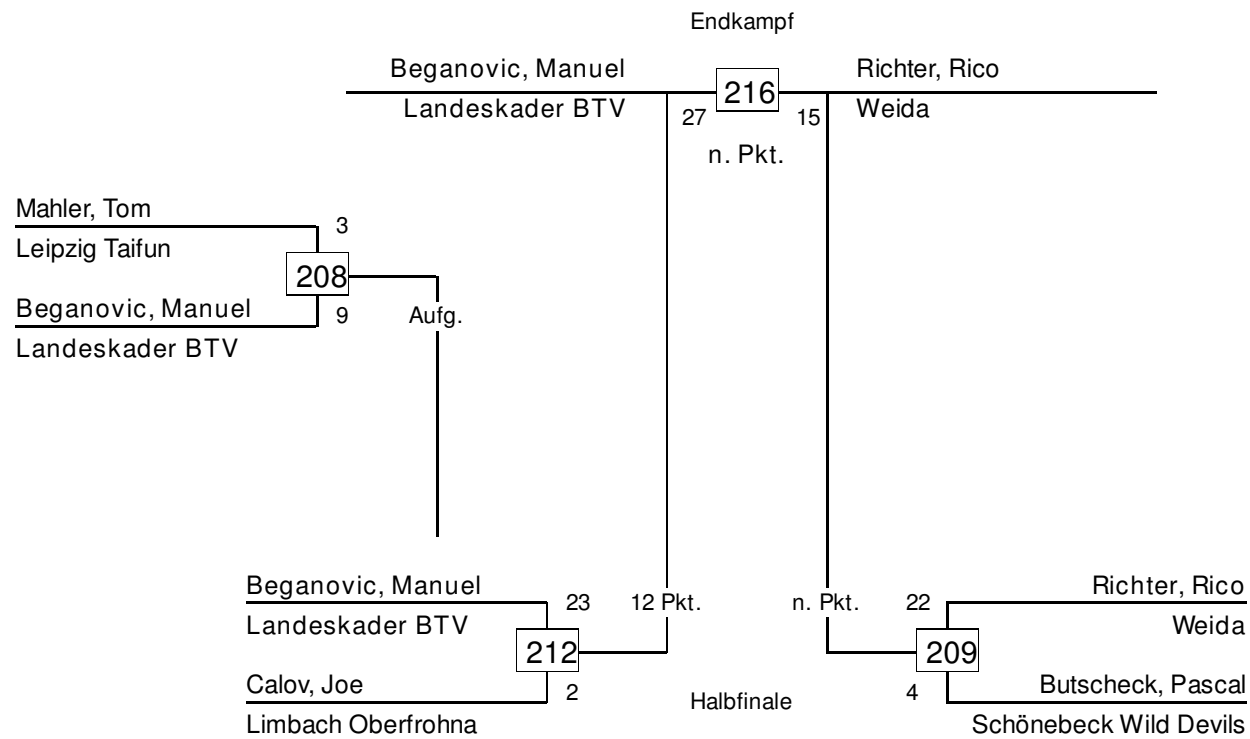

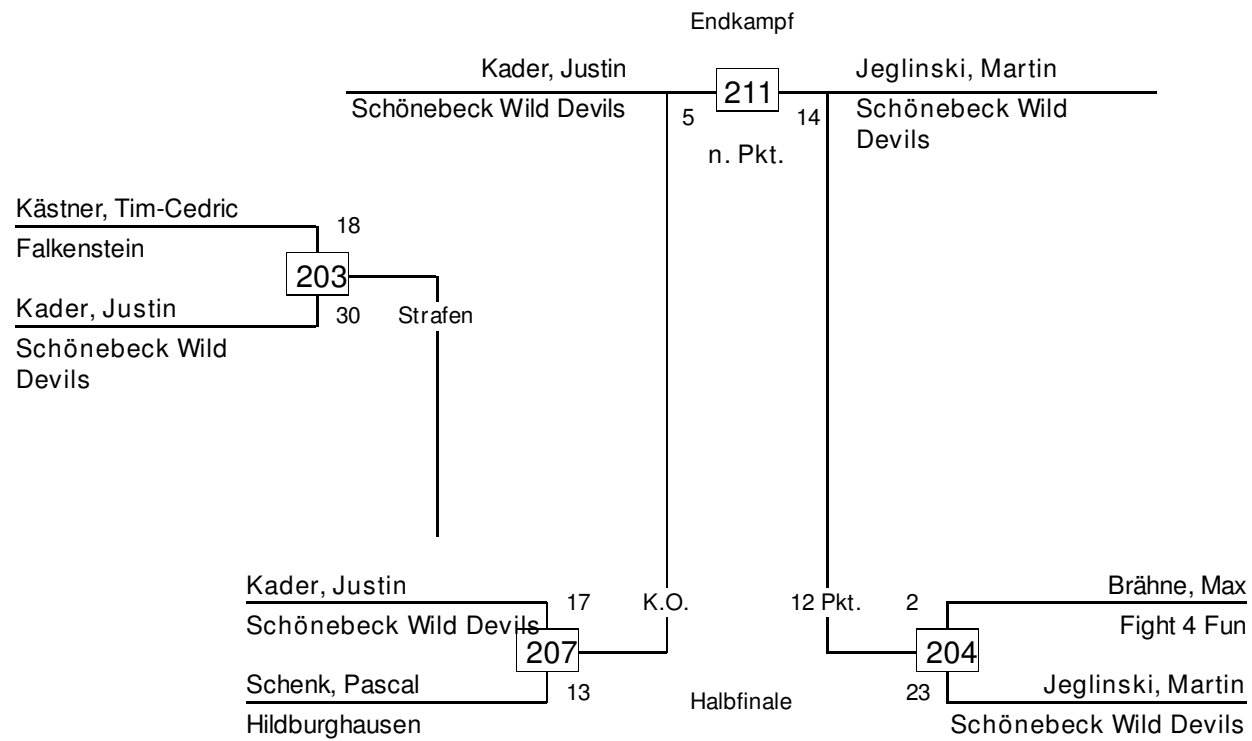

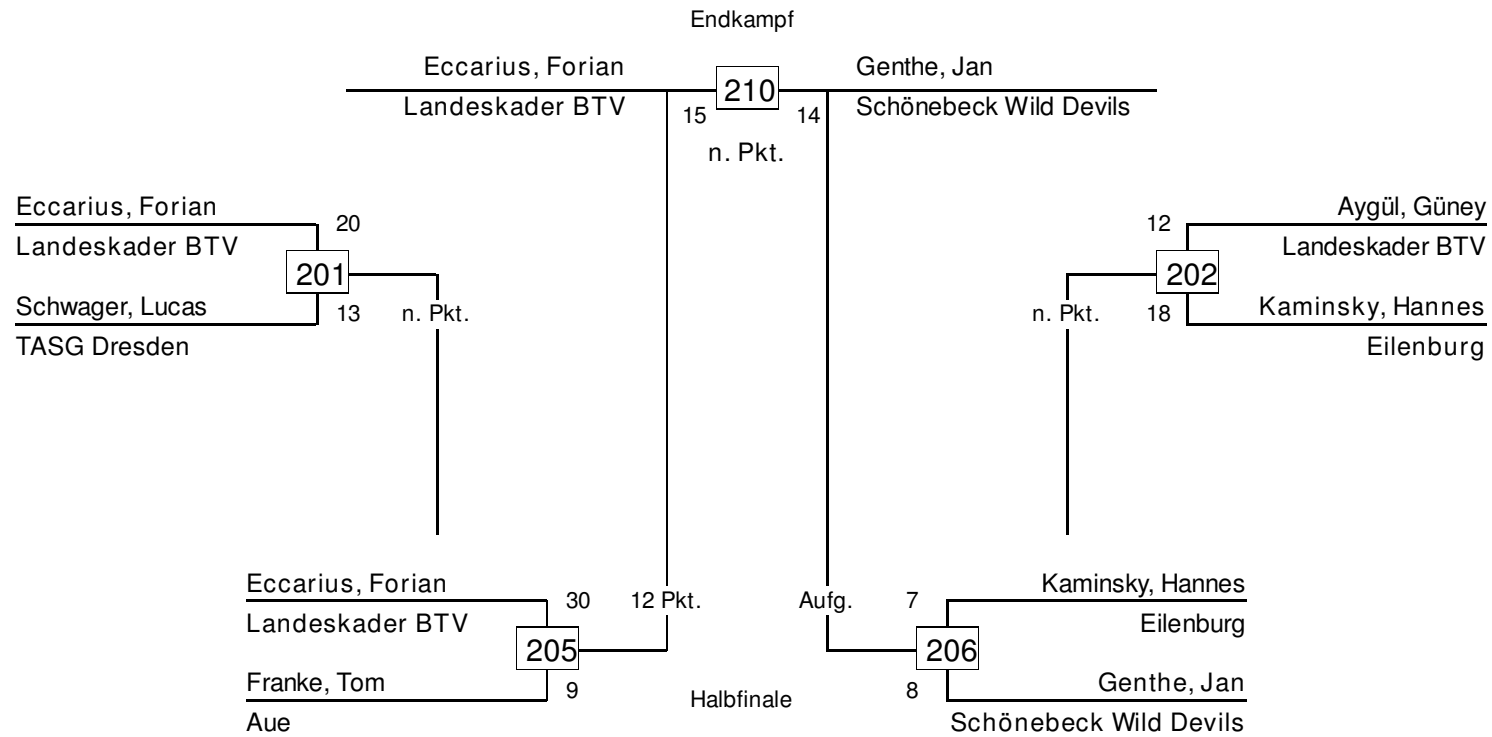

		Endkampf			
Ebert, Sören				Hocke, Max	
Aue	15	324	11	Meiningen	
		n. Pkt.			

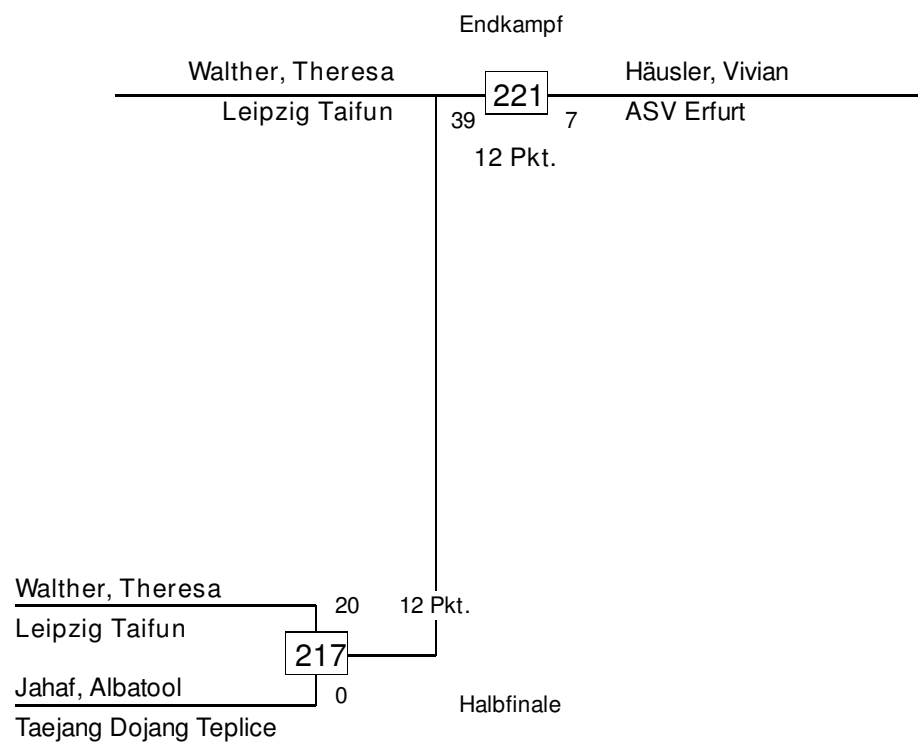

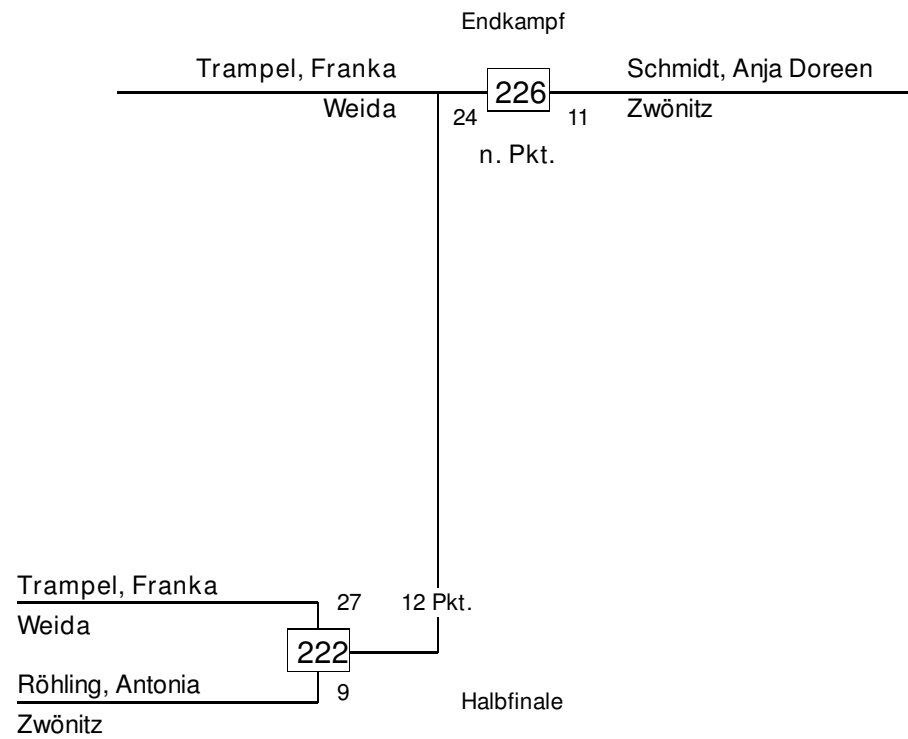

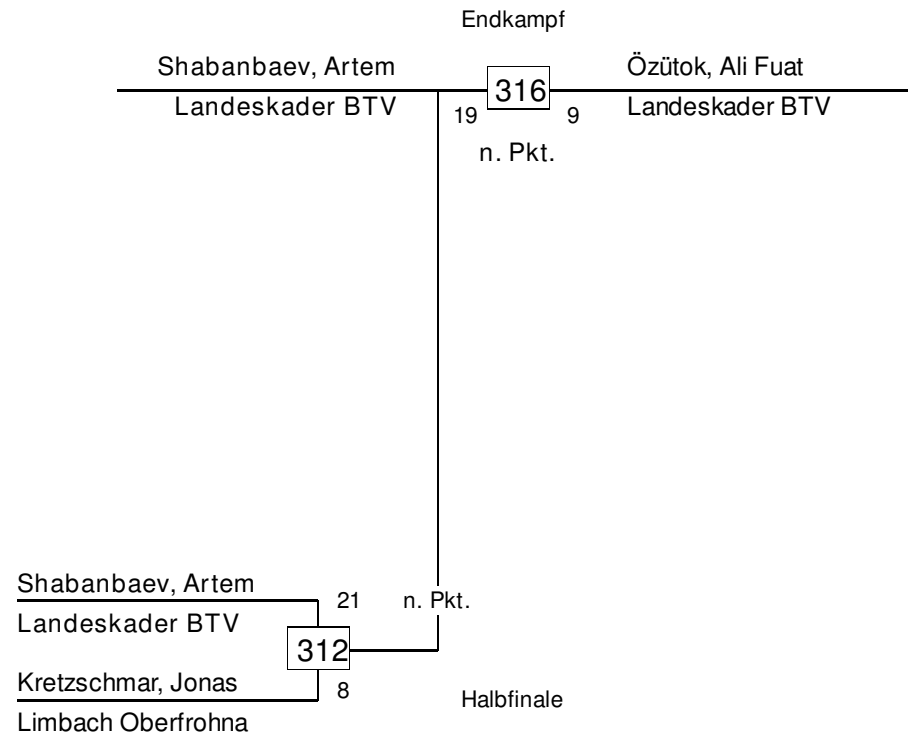

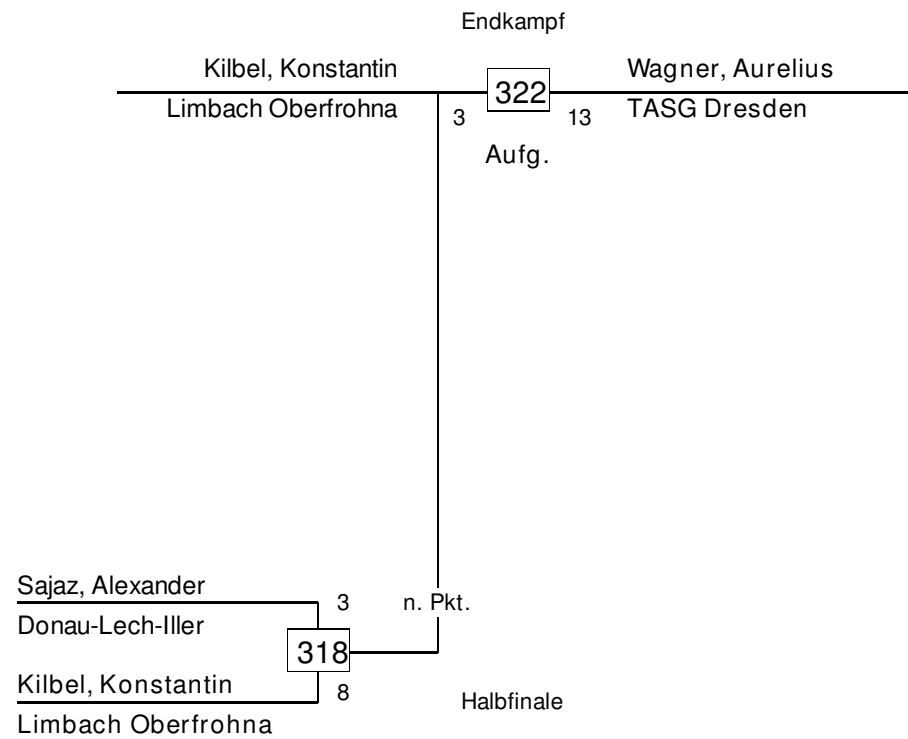

Endkampf

Klemm, Maximilian

Kuchar, Niels

TASG Dresden

Meiningen

9

321

8

n. Pkt.

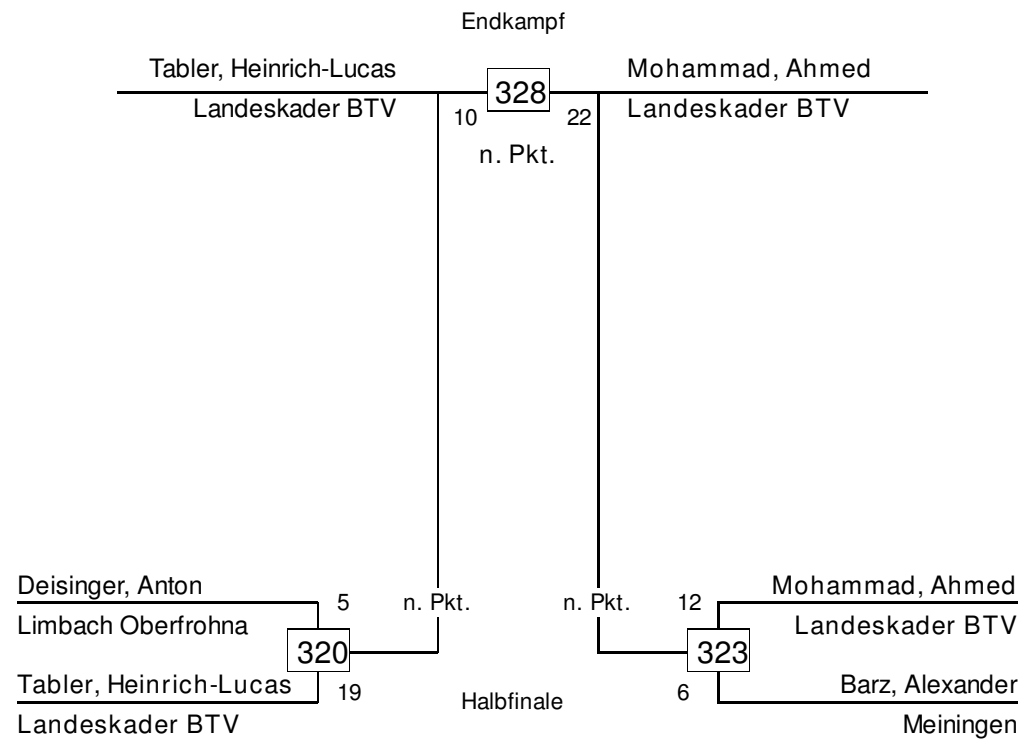

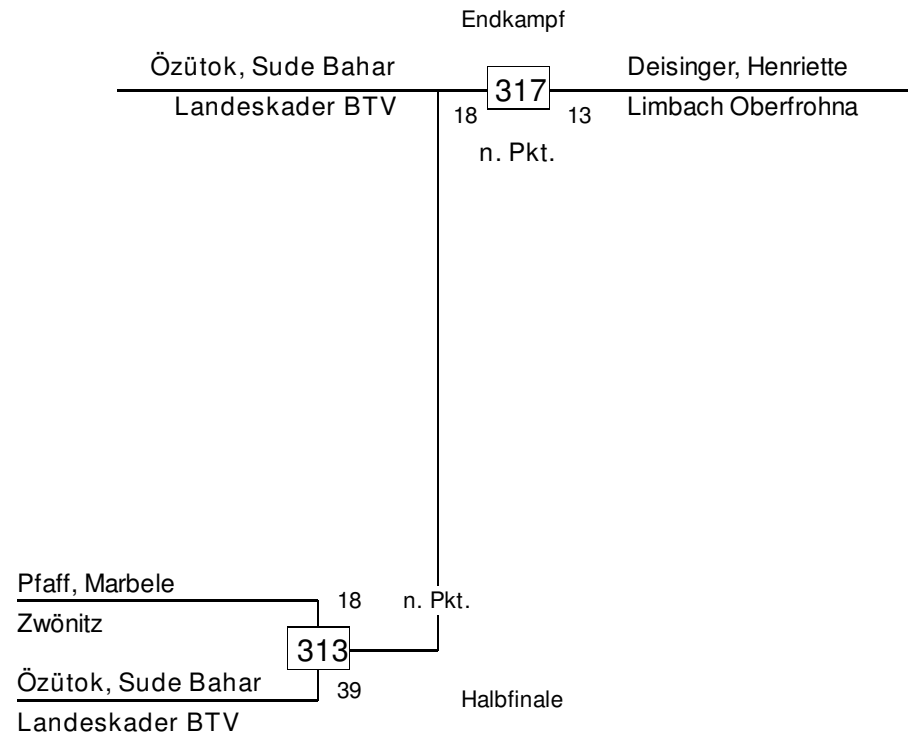

		Endkampf		
Hauser, Luisa		326		Buchholz, Emily
Zwönitz	22		4	Weida
		n. Pkt.		

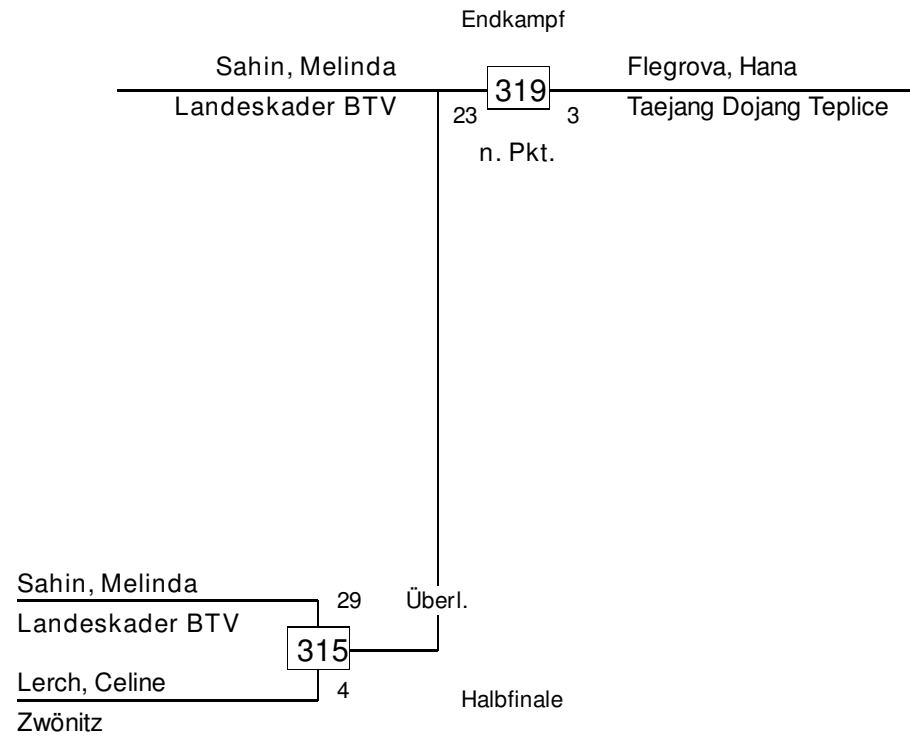

Endkampf

Limani, Arijeta				Reichelt, Chiara Sophie
Landeskader BTV	13	327	6	Limbach Oberfrohna
		Aufg.		

		Endkampf		
Gol Wali, Saeedi				Valy, Sohrab
Landeskader BTV	14	305	25	Landeskader BTV
		n. Pkt.		

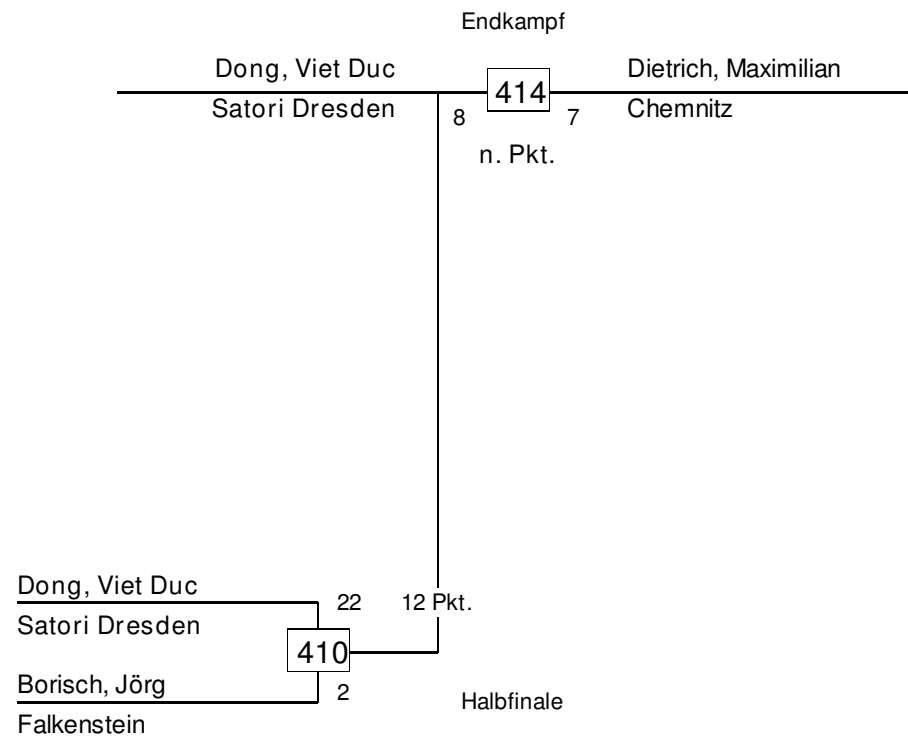

	Endkampf			
Müller, Tommy		Nötzold, Joachim		
Bautzen	16	<table border="1"><tr><td>310</td></tr></table>	310	3
310				
	n. Pkt.			
		Hohenstein-Ernstthal		

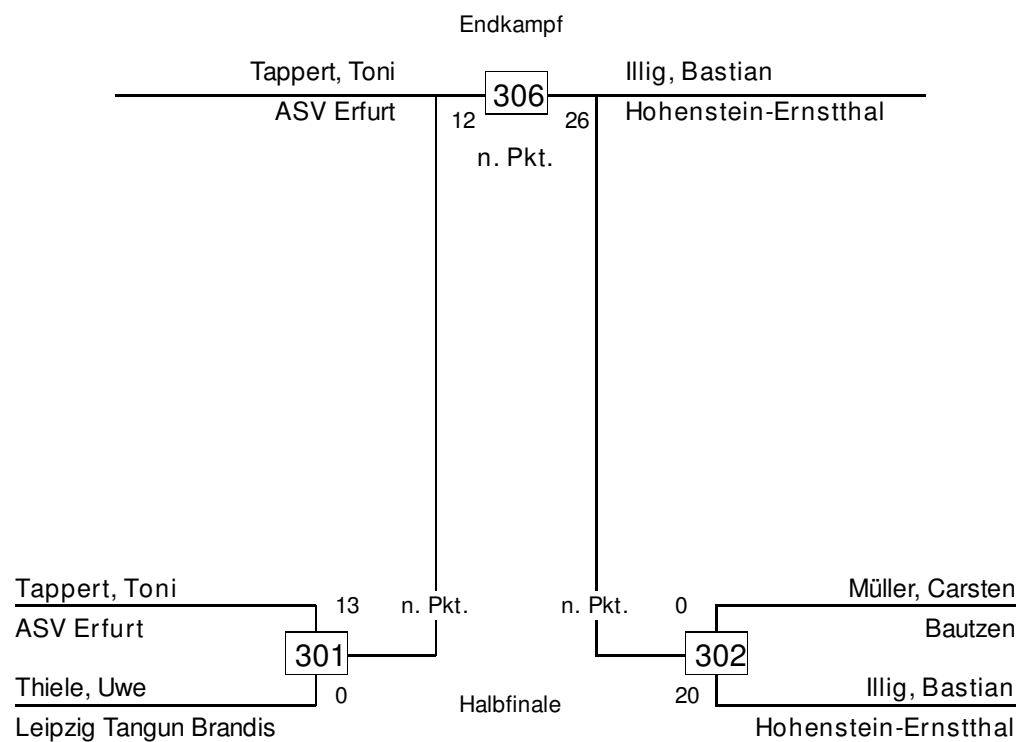

Endkampf

Stereov, Slatan		Grabe, Sebastian
Meiningen	6	ASV Erfurt
	309	12
	K.O.	

Endkampf

Nazari, Halil		Karge, Eric
Landeskader BTV	19 308 5	Satori Dresden

K.O.

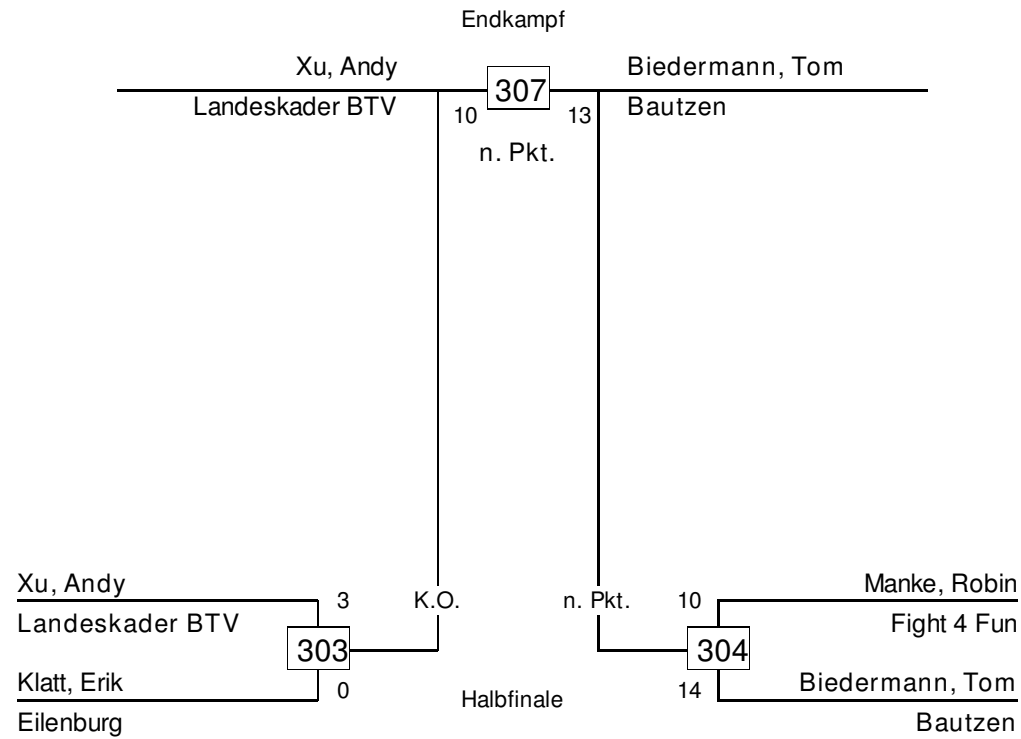

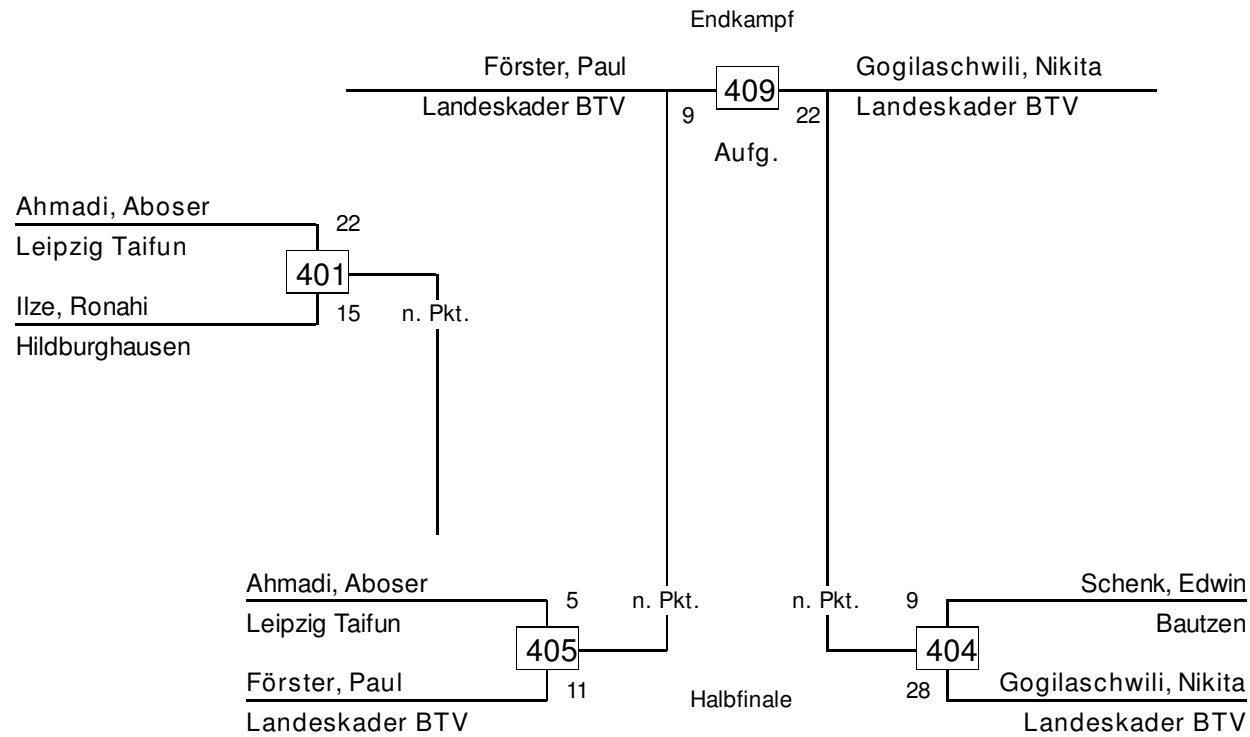

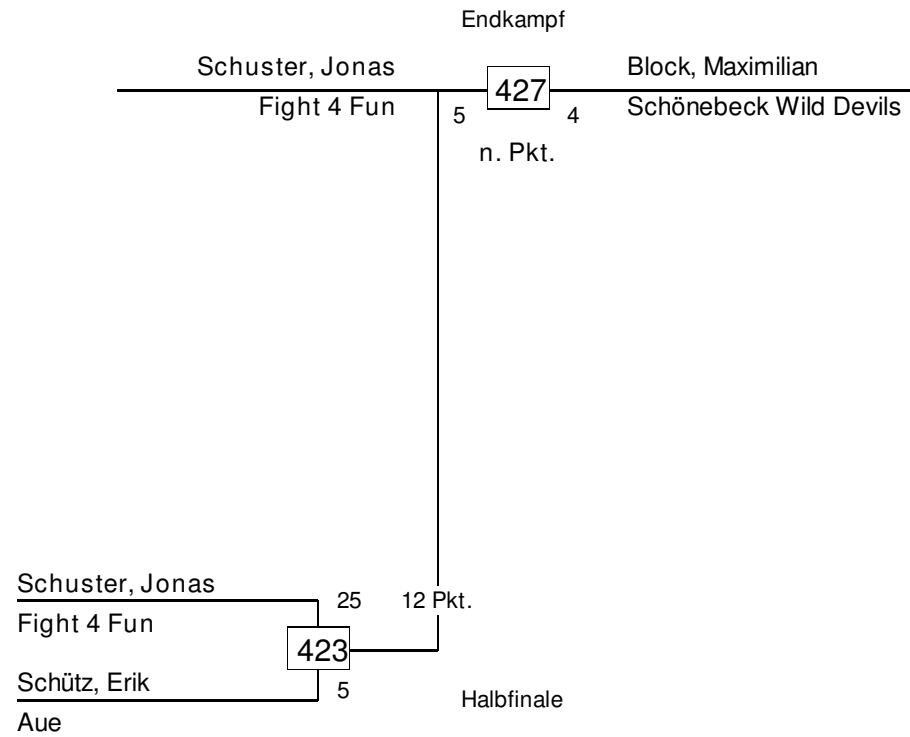

Endkampf

Klinger, Clara		Zander, Laura
Zwönitz	10 430 0	Meiningen

Aufg.

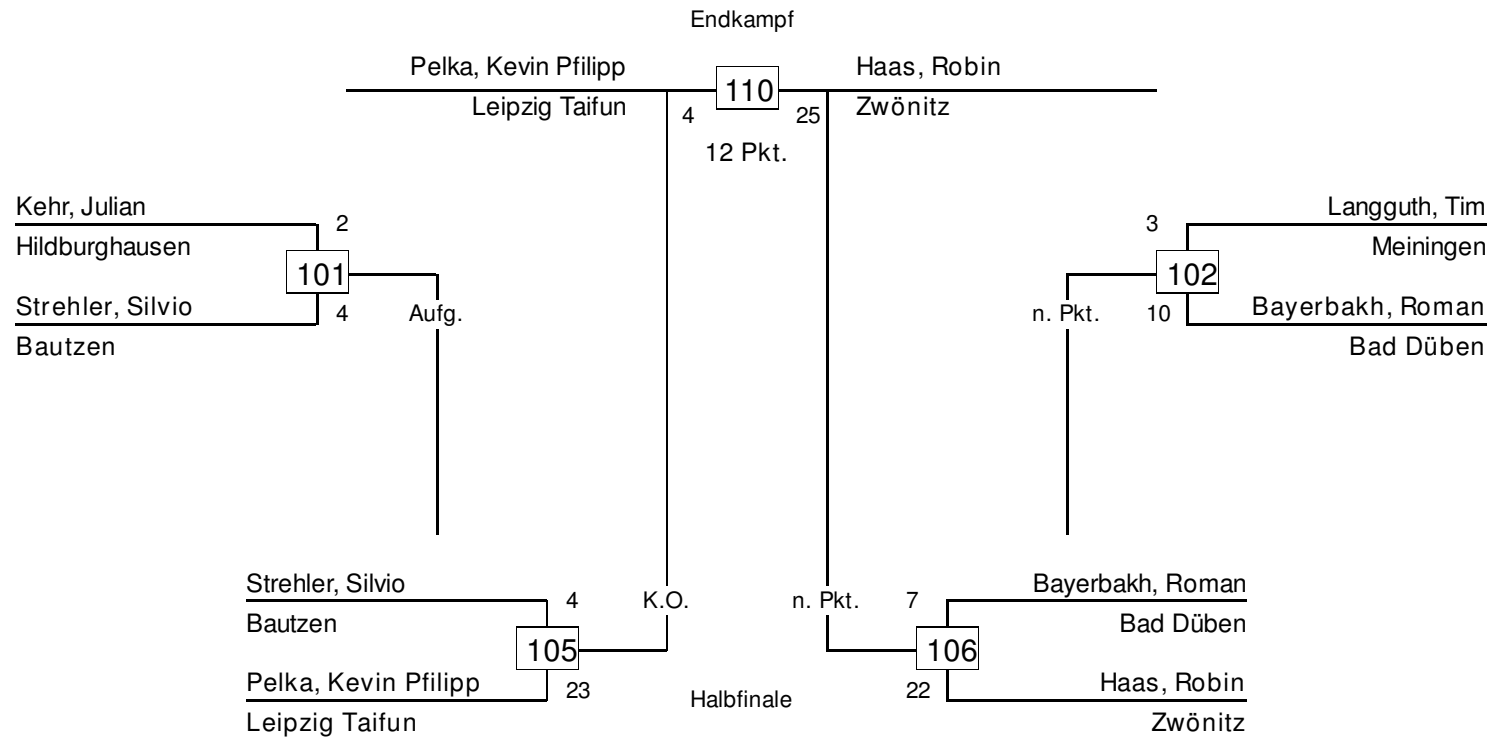

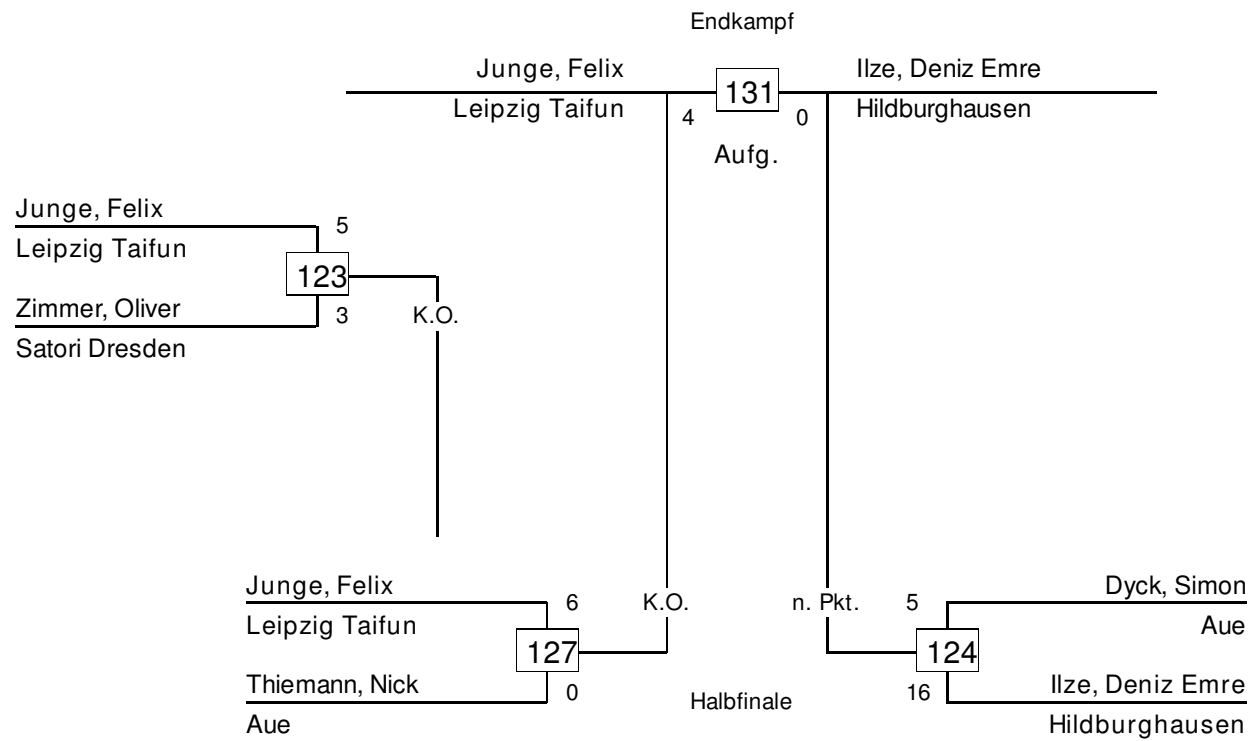

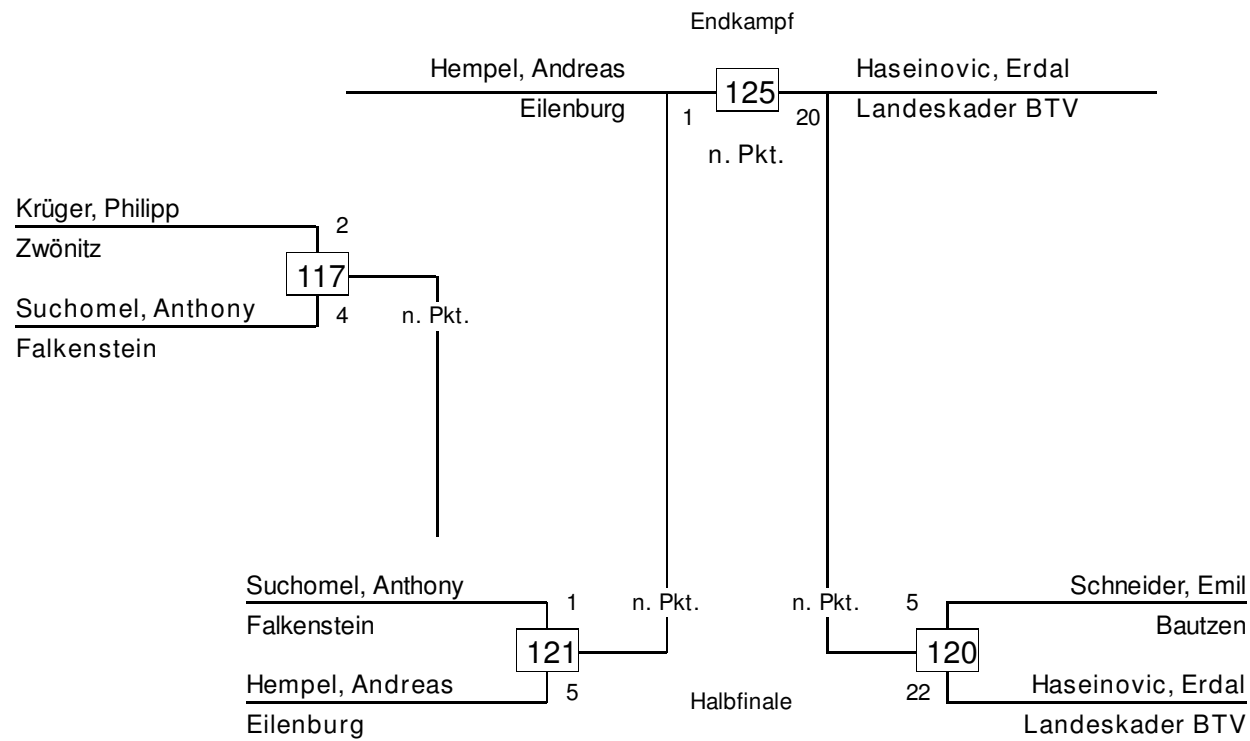

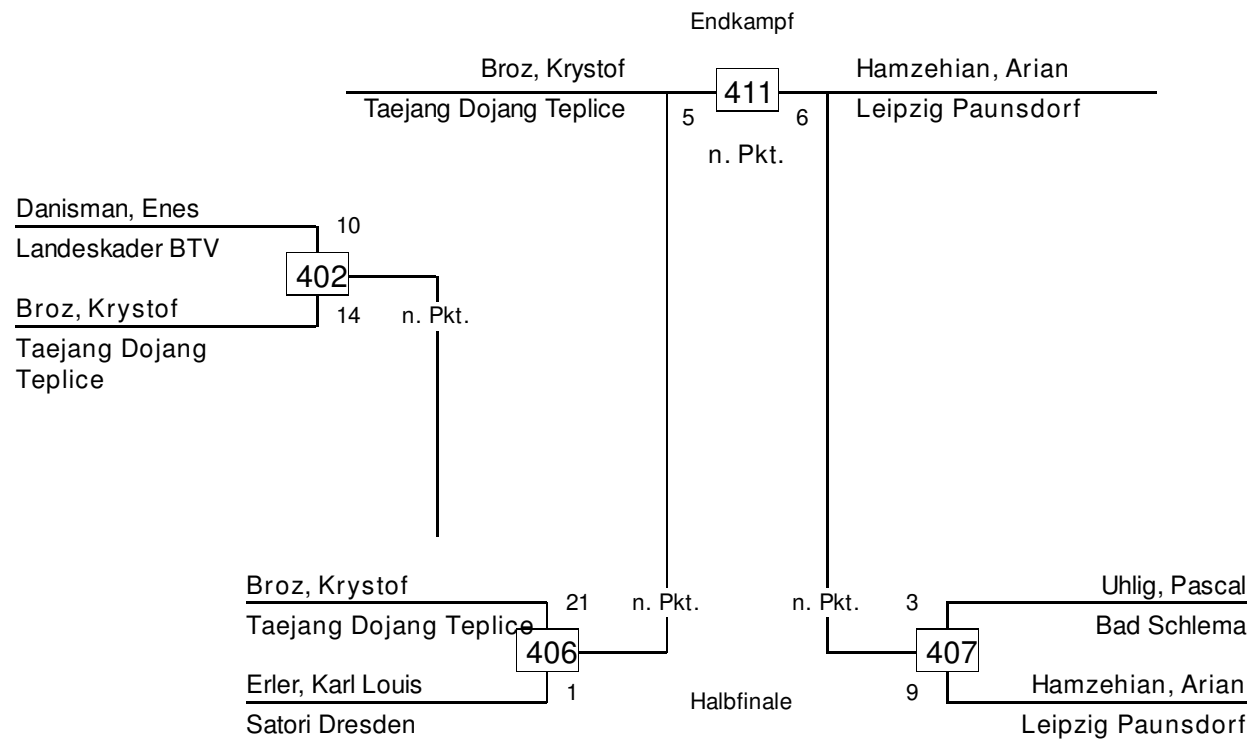

		Endkampf			
Erol, Kaan				Süß, Georg	
Landeskader BTV	4	426	2	Zwönitz	
		n. Pkt.			

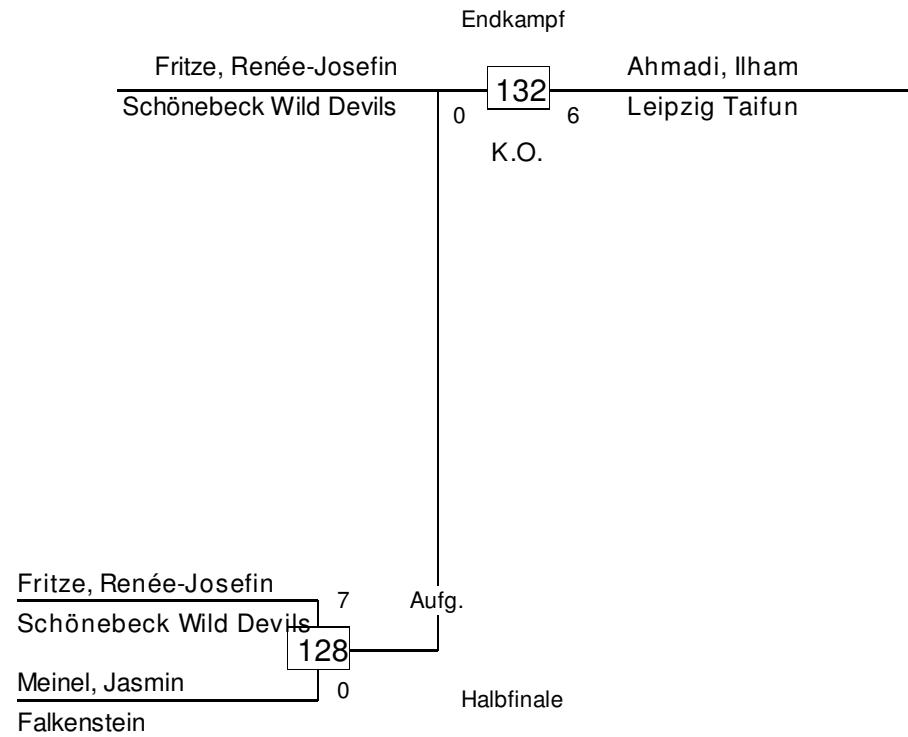

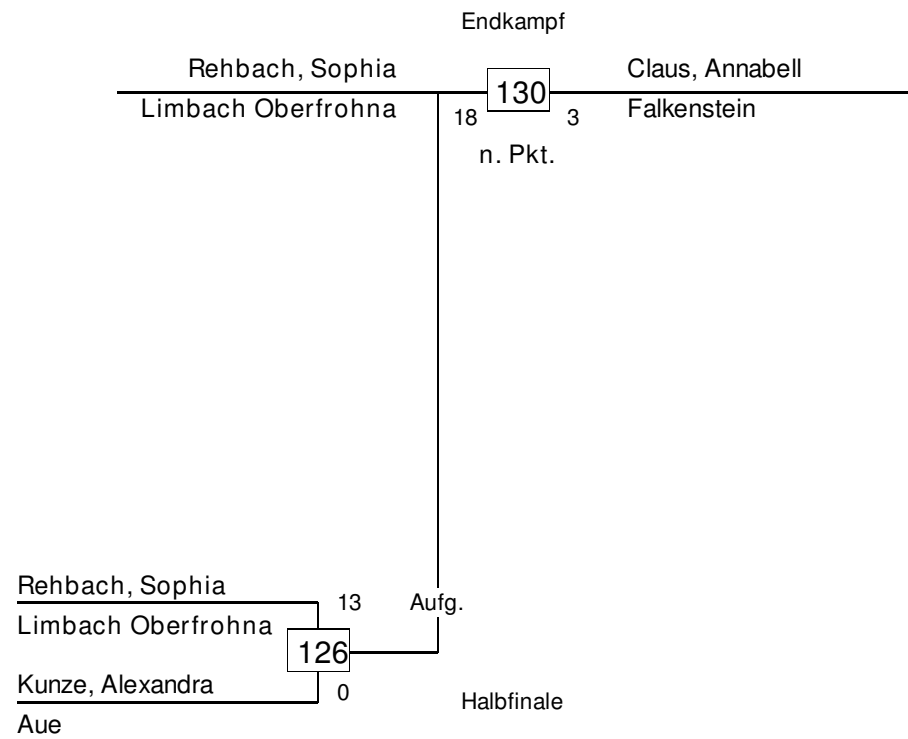

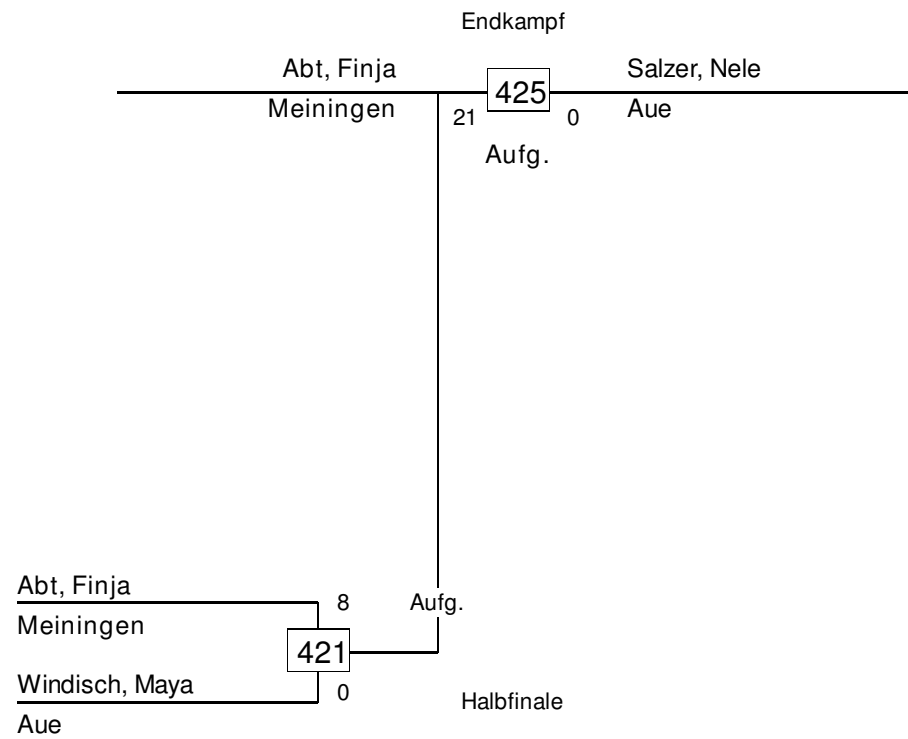

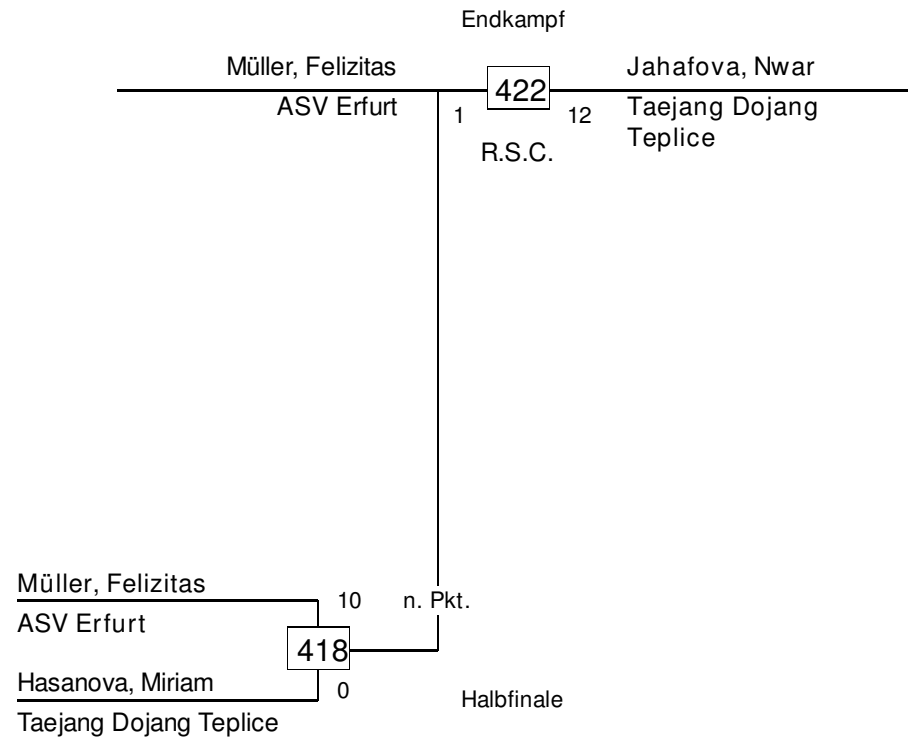

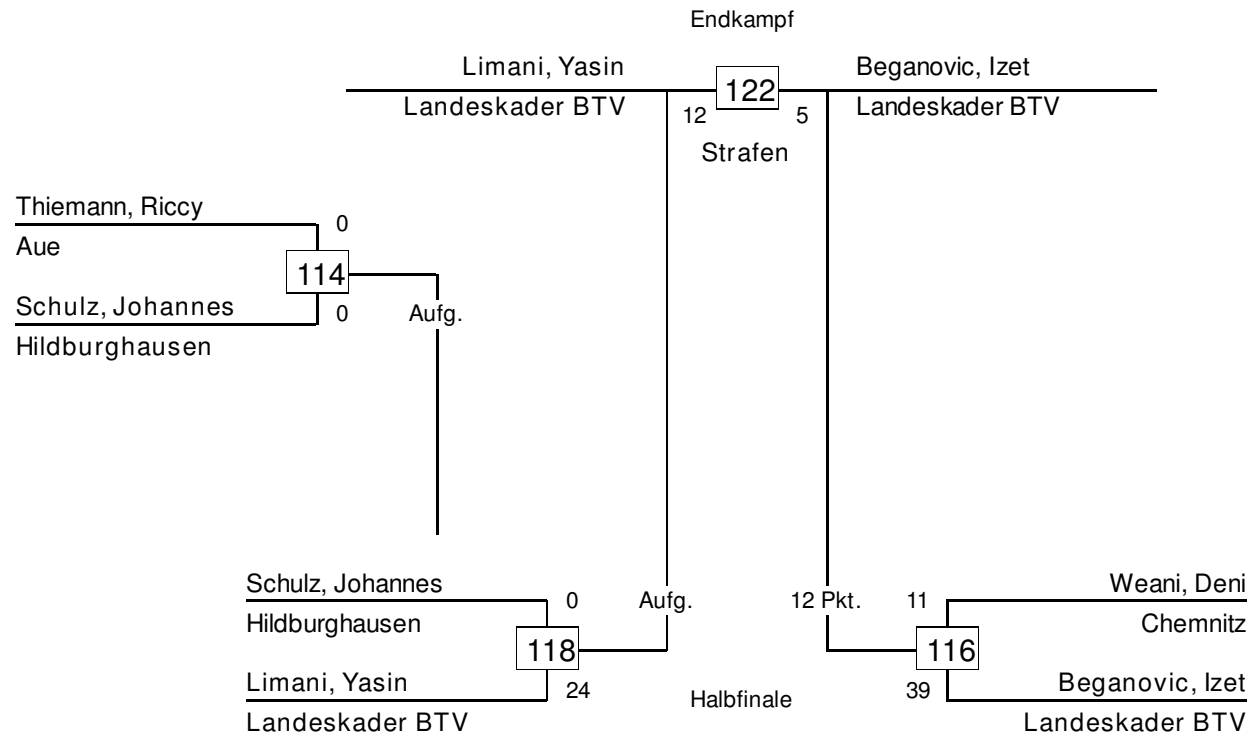

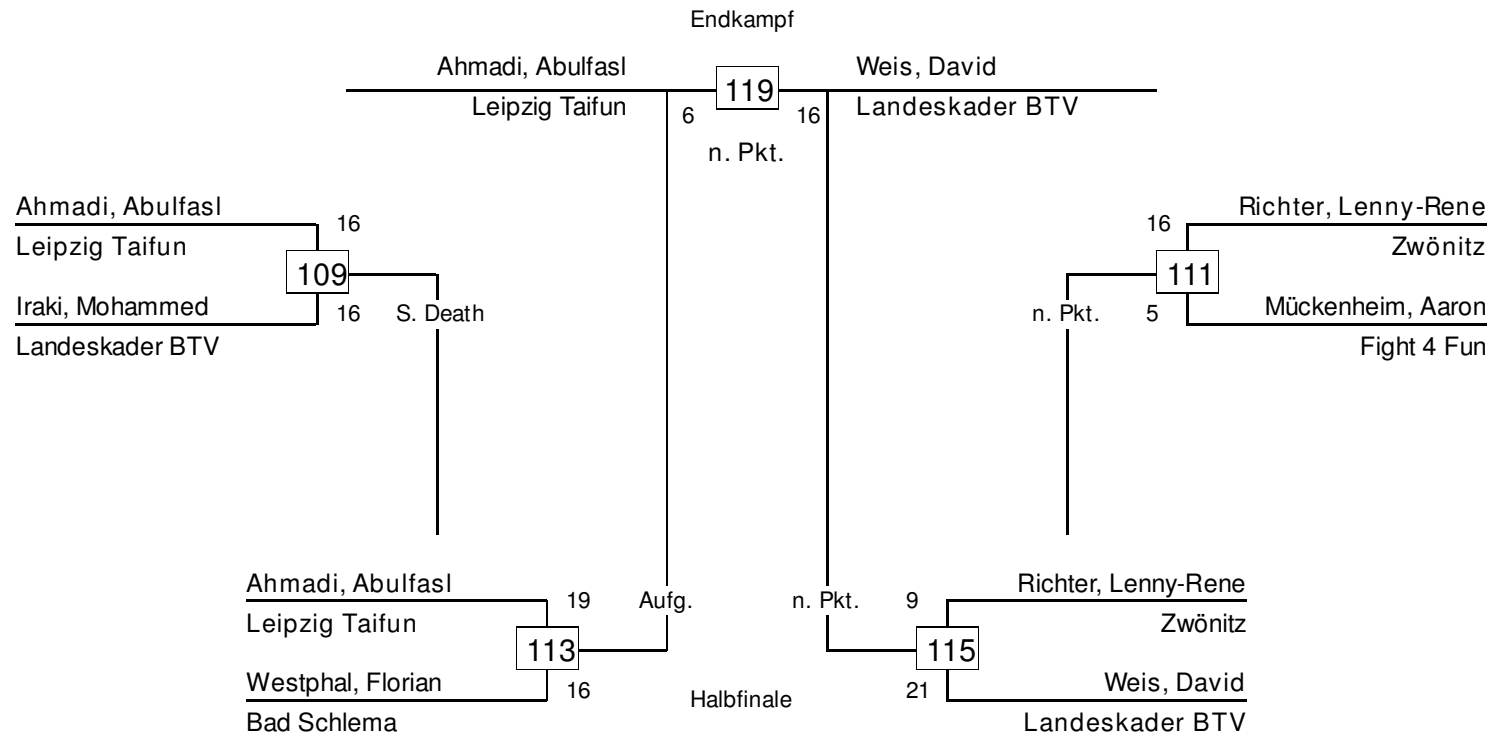

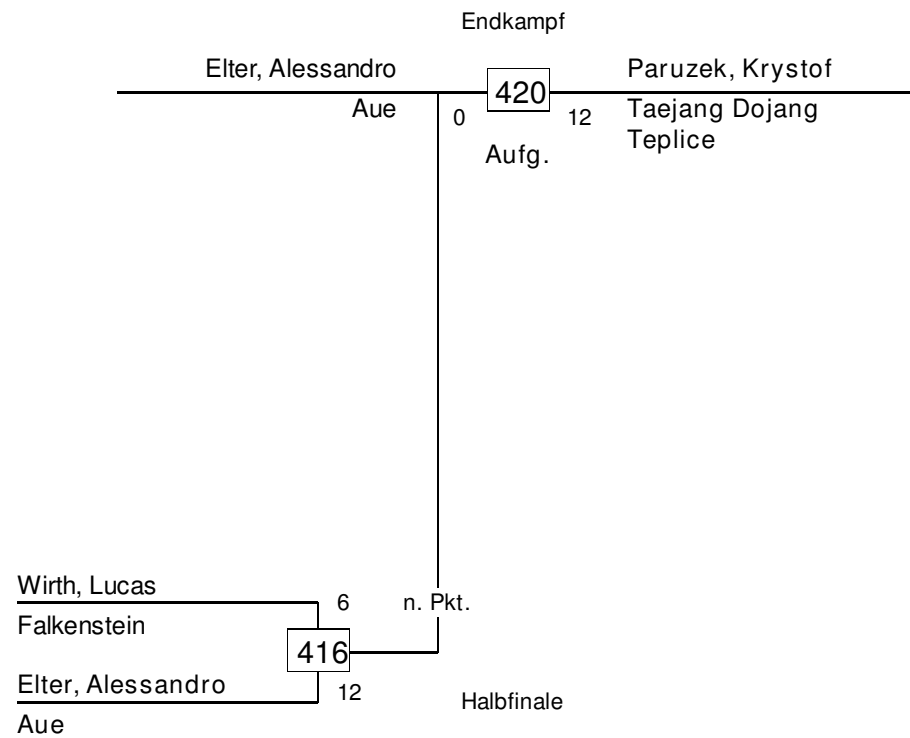

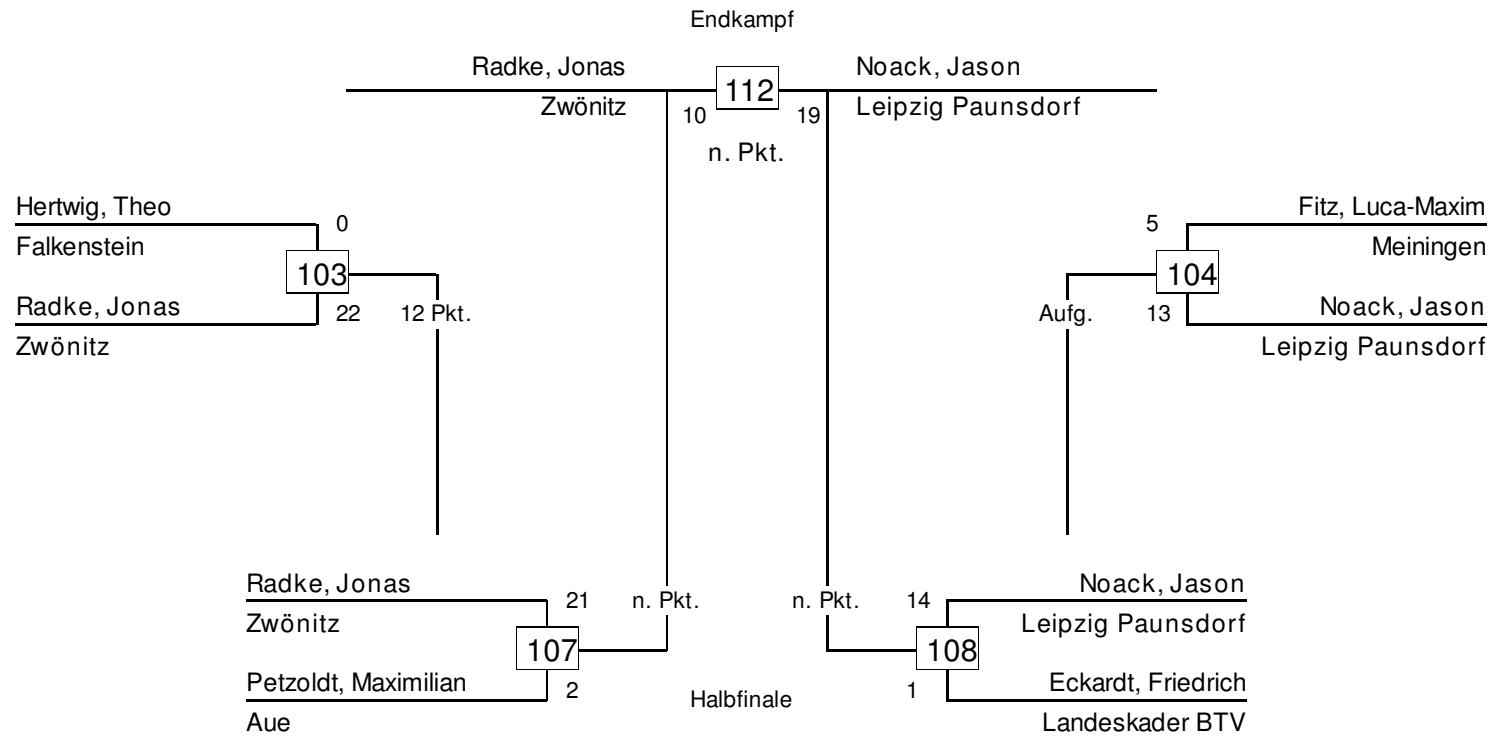

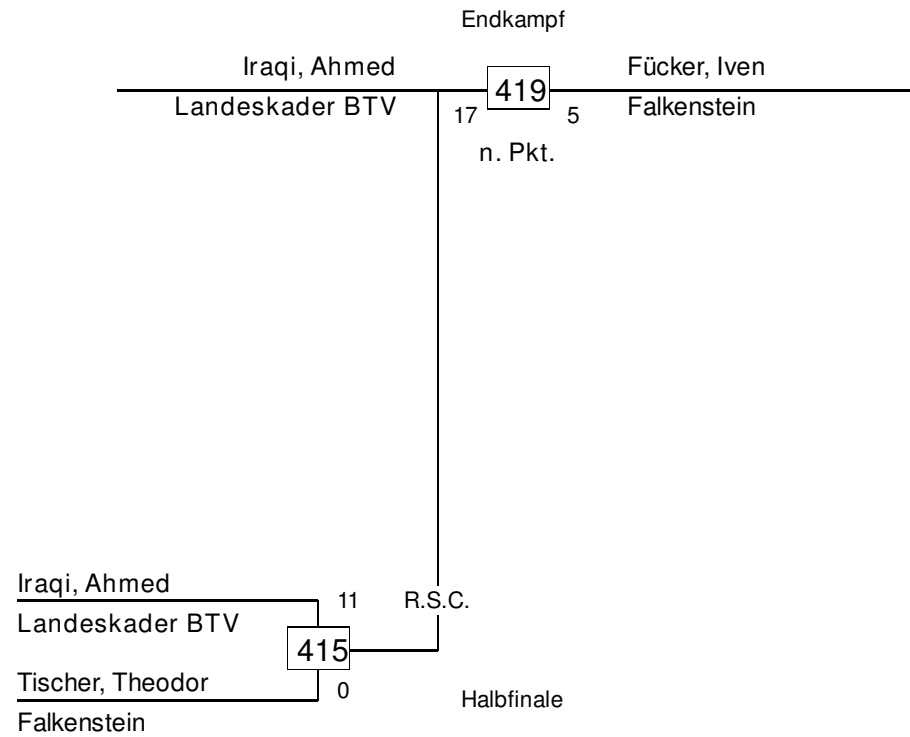

Endkampf

Beganovic, Sejfidin

Dähmow, Julien

Landeskader BTV

Eilenburg

25

429

6

12 Pkt.

		Endkampf		
Schickling, Phil				Friedrich, Ian
Aue	5	129	26	Hohenstein-Ernstthal
		12 Pkt.		

Endkampf

Erol, Havin Zeliha						Limani, Elmedina
Landeskader BTV	1	133	11			Landeskader BTV
				Aufg.		

